

# URW-546-2 (4.0T X 2.5M)

# SPIDER PLUS

- Total width 1.4m
- Max working radius 17m with searcher and single-line hooks
- Tier 4 diesel engine powered and optional mains electric
- Zero length increase with electric option
- Operator control of outrigger extension
- Intelligent voice warning system
- Radio remote control as standard
- Working area limitation (optional)
- Variable footprint (optional)
- Intelligent throttle activation for economy and ecology

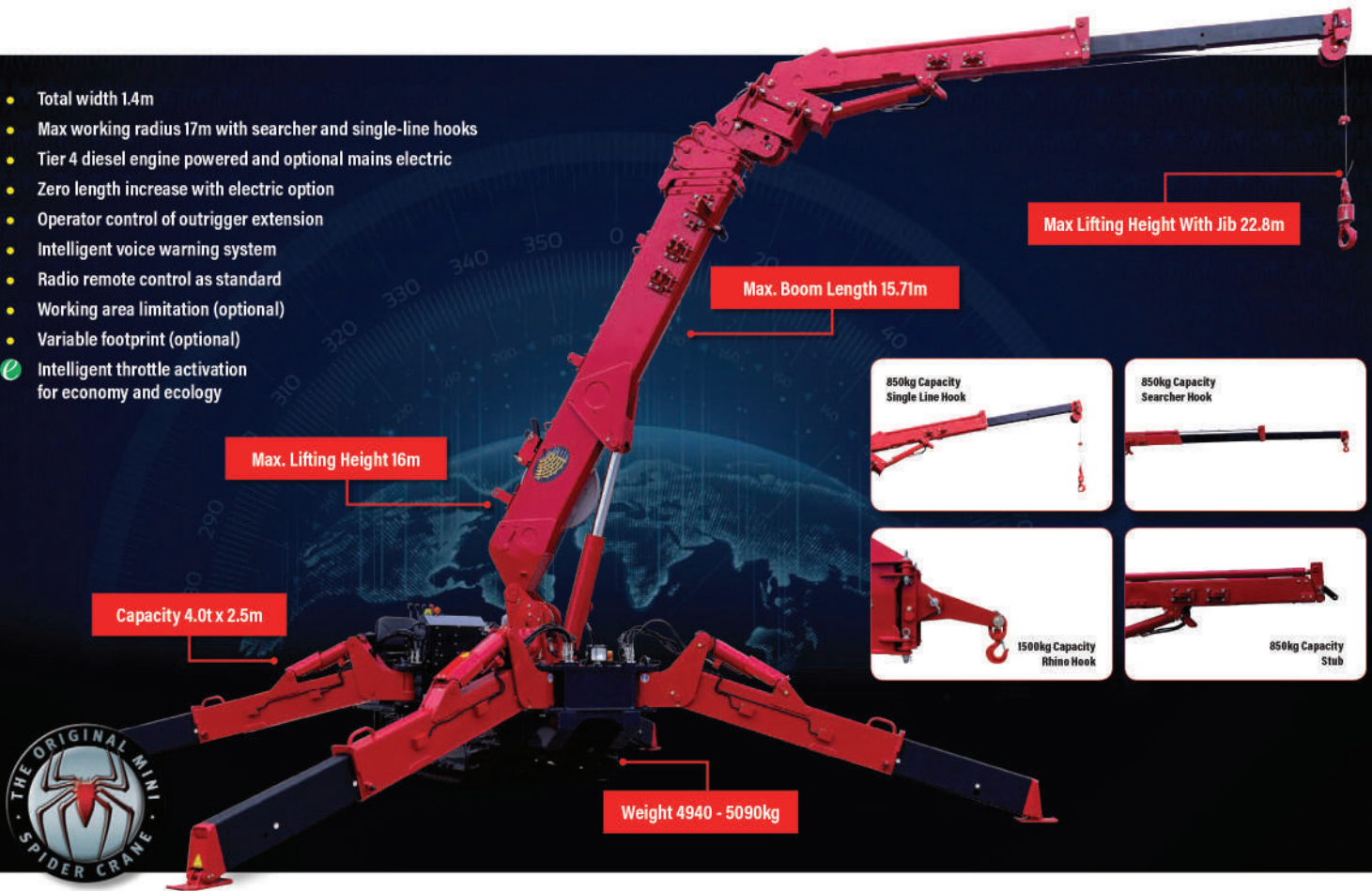

The UNIC URW-546-2 seamlessly combines operational flexibility with robust lifting power, featuring a new hydraulic jib with four hook options – the new model surpasses the standard URW-546 model with an expanded working height of up to 22.8m and an increased working radius of 17m. The URW-546-2 boasts a slim 1.4m width for adept manoeuvrability through internal industrial doorways and operation in confined spaces. Features include an optional upgrade to the variable footprint system, enhancing crane flexibility. The 546-2 seamlessly integrates into the UNIC crane range, maintaining unrivalled performance and reliability while introducing heightened flexibility and usability.

## CRANE SPECIFICATIONS

Crane capacity	capacity:	4.0t x 2.5m
Max working radius	max:	15.52m (17m with single line hook, 17m with fixed hook)
Max lifting height	approx:	16m (21.8m with single line hook, 22.8m with fixed hook)
Rope length	max:	20.52m (4 fall), 42.54m (2 fall), 86.57m (1 fall)
Dimensions	folded:	5270mm (l) x 1300mm (w) x 2090mm (h)
Weight	unladen:	5280kg (5430kg with electric option)
Point loadings	Due to the many variables involved, point loadings are only available on request	
Hook speed	approx:	11m/min (with 4 layers and 4 falls)
Telescopic system	boom length:	3.93 - 15.71m
	telescoping speed:	11.78m / 35 seconds
	boom type:	6 section hydraulically telescoping boom, hexagonal box construction
Derricking angle/speed	approx:	0 - 80° / 18.0 seconds
Slewing angle/speed	approx:	360° (continuous) 2.5min rpm
Traction system	drive:	hydrostatic 2-speed, stepless forward and reverse
	travel speed:	0 - 3km/h
	gradeability:	± 20° (vertical), 20° (traverse)
	track ground length:	1750mm
	track ground pressure:	46.1 kPa (0.47kg/cm <sup>2</sup> )
	track width:	300mm
Engine	manufacturer:	Tier 4 Yanmar
	fuel:	diesel
	maximum output:	17.8kW (23.9PS) / 3000min rpm
	starting method:	electric
	tank capacity:	40 litres
Electric dual power option	power:	75kW
	voltage:	400v AC 50/60Hz
Standard equipment	computer controlled moment limiter (safe load indicator), radio remote control, overwinding alarm, computer controlled intelligent voice warning system, multi-function operation by radio remote control, intelligent throttle activation, automatic hook stow, overload warning alarms, overload warning lamps, 850kg capacity single-line hook, 850kg capacity searcher hook, 850kg capacity stub, 1500kg capacity rhino hook	
Optional equipment	2 fall hook block, mains electric dual power (400v), low marking tracks, slew limitation, radio remote control with feedback display, data logging, forward facing camera, variable footprint option, working area limitation	

## ADDITIONAL FEATURES



Radio remote control



Safe load indicator



Optional Variable Footprint safe load indicator

# URW-546-2 (4.0T X 2.5M)

# SPIDER PLUS

## MAIN BOOM RATED LOADS WITH OUTRIGGERS SET TO MAX & OUTRIGGER POSITIONS

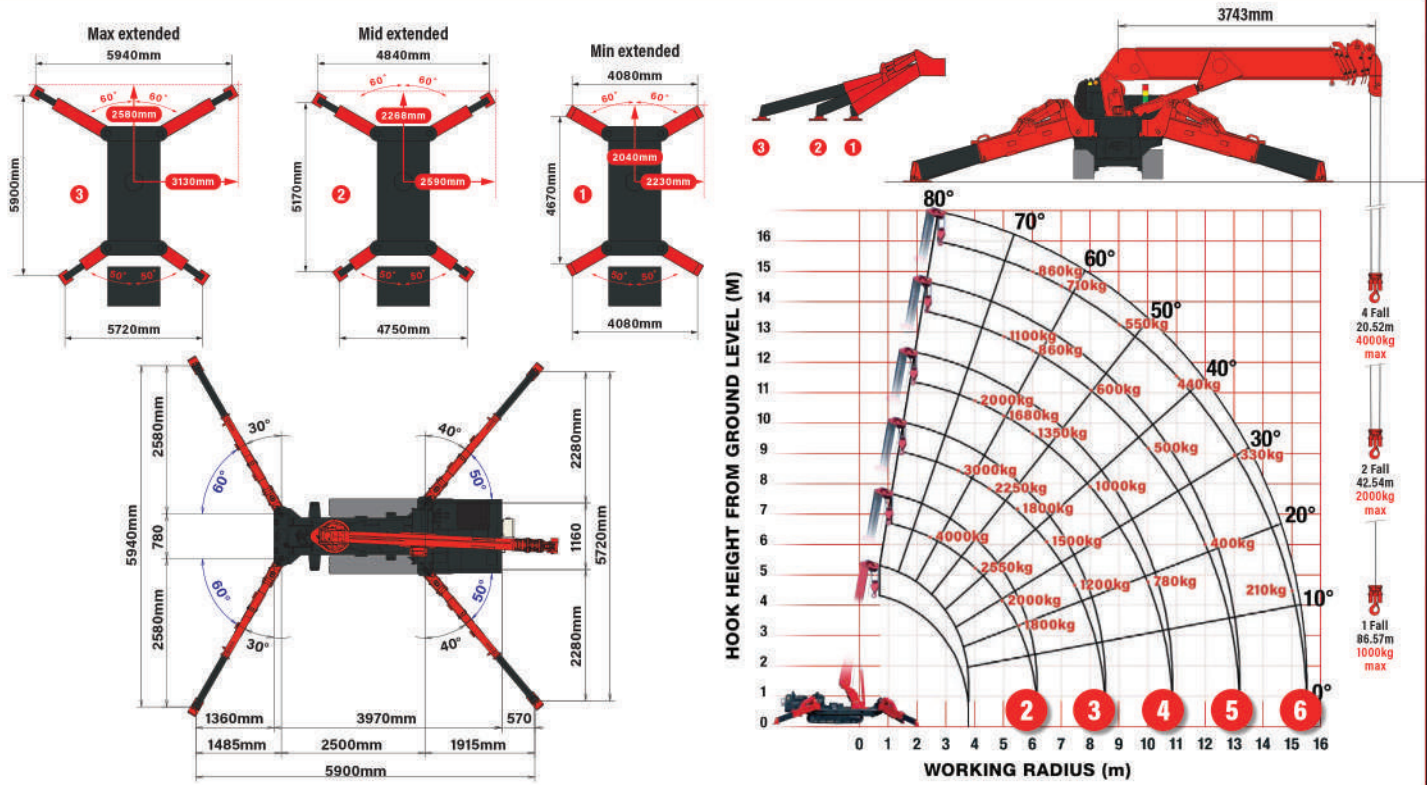

### SECOND STAGE EXTENDED 3.93 - 6.33m BOOM LENGTH

Working radius	m	up to 2.5	3.0	3.5	4.0	4.5	5.0	5.5	6.0	6.14		
Outrigger	Max-extended	without/with jib	kg	4000	3450	3000	2550	2250	2000	1800	1630	1600
	Mid-extended	without/with jib	kg	4000	3450	3000	2450	2100	1850	1700	1400	1350
	Min-extended	without/with jib	kg	4000	3450	3000	2400	2000	1650	1350	1100	1000

### THIRD STAGE EXTENDED 6.33 - 8.72m BOOM LENGTH

Working radius	m	up to 3.5	4.0	4.5	5.0	5.5	6.0	6.5	7.0	7.5	8.0	8.53		
Outrigger	Max-extended	without/with jib	kg	3000	2550	2250	2000	1800	1650	1500	1350	1200	1100	1000
	Mid-extended	without/with jib	kg	3000	2400	2100	1850	1700	1400	1200	1050	850	750	620
	Min-extended	without/with jib	kg	3000	2400	2000	1650	1350	1100	900	750	600	500	450

### FOURTH STAGE EXTENDED 8.72 - 11.05m BOOM LENGTH

Working radius	m	up to 4.0	4.3	4.5	5.0	5.5	6.0	7.0	8.0	9.0	10.0	10.9		
Outrigger	Max-extended	without/with jib	kg	2000	2000	1880	1680	1500	1350	1150	1000	900	780	650
	Mid-extended	without/with jib	kg	2000	2000	1800	1600	1450	1300	1050	700	600	450	390
	Min-extended	without/with jib	kg	2000	2000	1800	1600	1350	1100	750	500	400	300	250

### FIFTH STAGE EXTENDED 11.05 - 13.38m BOOM LENGTH

Working radius	m	up to 5.0	5.5	6.0	7.0	8.0	9.0	10.0	11.0	12.0	13.20		
Outrigger	Max-extended	without/with jib	kg	1100	950	860	710	600	550	500	450	400	350
	Mid-extended	without/with jib	kg	1100	950	860	700	600	520	450	390	300	250
	Min-extended	without/with jib	kg	1100	950	860	700	500	400	300	250	200	170
	Min-extended	with jib	kg	1100	950	860	700	500	400	300	250	200	140

### SIXTH STAGE EXTENDED 13.38 - 15.71m BOOM LENGTH

Working radius	m	up to 6.0	7.0	8.0	9.0	10.0	11.0	12.0	13.0	14.0	15.0	15.52	
Outrigger	Max-extended	without/with jib	kg	860	710	600	550	500	440	390	330	270	210
	Mid-extended	without/with jib	kg	860	500	350	300	270	250	220	200	170	160
	Min-extended	without/with jib	kg	860	500	350	300	250	230	200	170	150	120
	Min-extended	with jib	kg	860	500	350	300	250	230	200	140	90	60

## DIMENSIONS

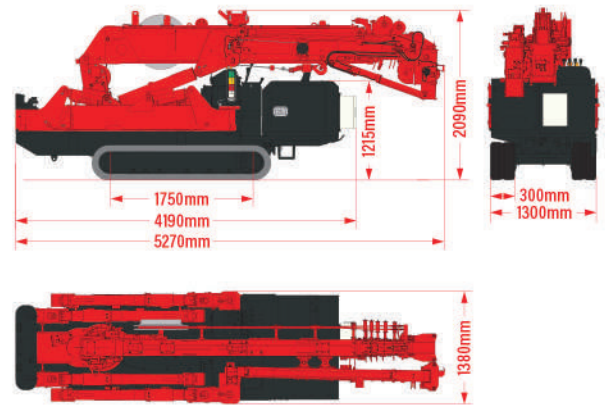

## ATTACHMENT WORKING RANGES

### Single-Line Hook

Maximum Load - 850kg

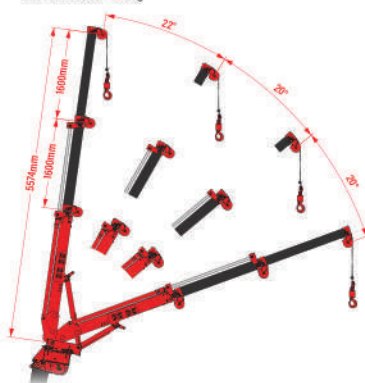

### Searcher Hook

Maximum Load - 850kg

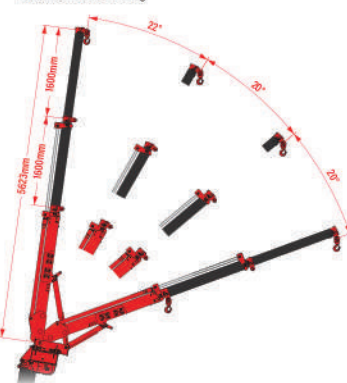

### Stub

Maximum Load - 850kg

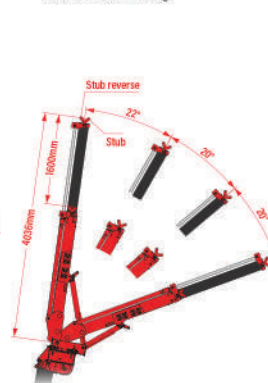

### Rhino Hook

Maximum Load - 1500kg



# URW-546-2 (4.0T X 2.5M)

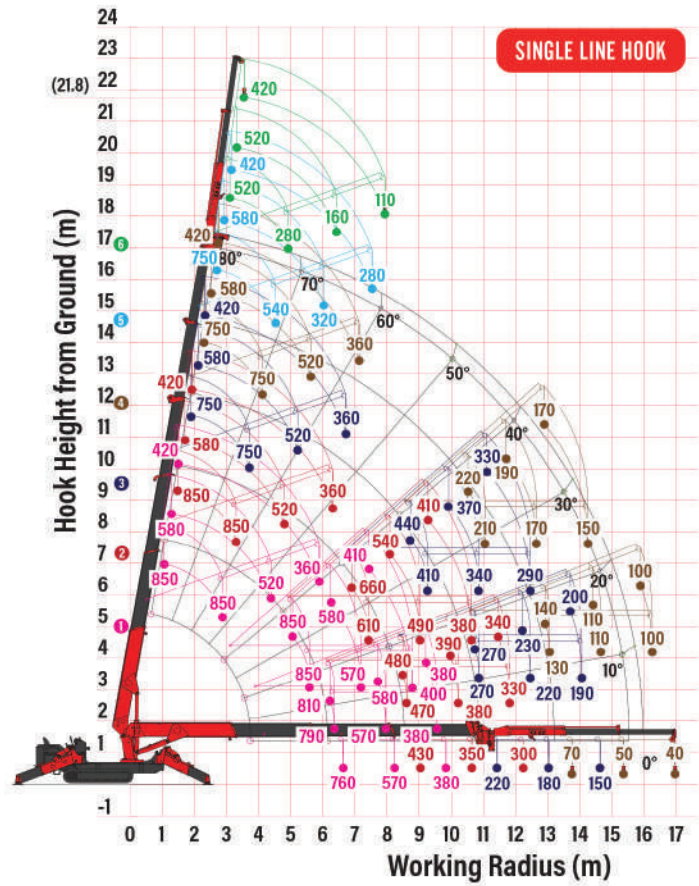
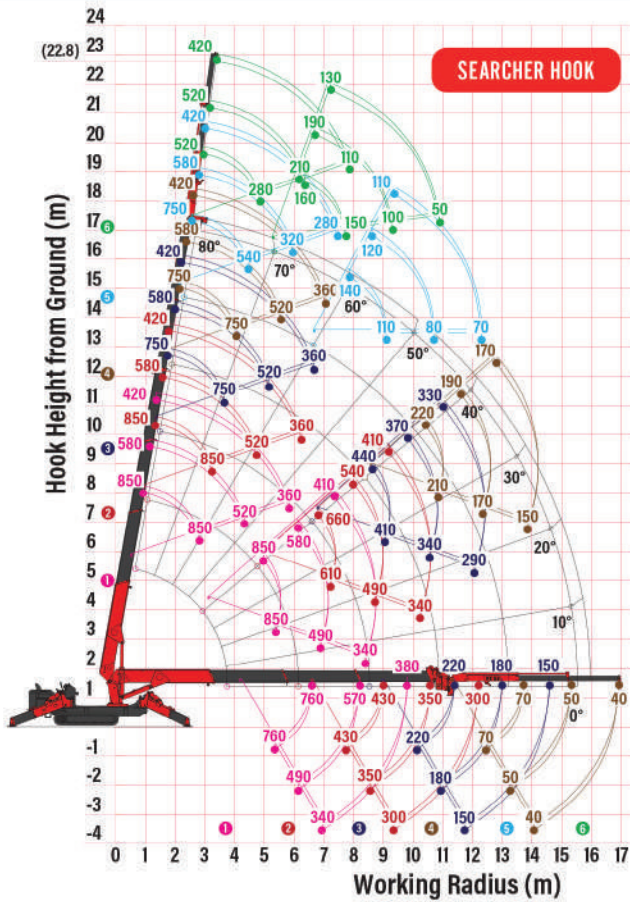

## HYDRAULIC JIB NET RATED LOADS (kg) - ANGLE RATED - OUTRIGGERS SET TO MAXIMUM AND HALFWAY

PROHIBITED AREA OF SINGLE LINE HOOK

JIB 1 / STUB 1	BOOM 1					BOOM 2					BOOM 3					BOOM 4					BOOM 5					BOOM 6						
	TILT ANGLES	0°	20°	40°	60°	TILT ANGLES	0°	20°	40°	60°	TILT ANGLES	0°	20°	40°	60°	TILT ANGLES	0°	20°	40°	60°	TILT ANGLES	0°	20°	40°	60°	TILT ANGLES	0°	20°	40°	60°		
JIB 1 / STUB 1	80°	850	850	850	850	80°	850	850	850	850	80°	750	750	750	750	80°	750	750	750	750	80°	750	720	600	540	80°	520	410	310	280		
	70°	850	850	850	850	70°	850	850	850	800	70°	750	750	750	750	70°	750	720	650	540	70°	330	280	250	240	70°	210	180	160	150		
	60°	850	850	850	850	60°	750	750	750	750	60°	750	720	670	660	60°	500	450	420	420	60°	140	120	120	110	60°	70	60	60	60		
	50°	850	850	850	850	50°	750	750	730	730	50°	580	530	520	520	50°	310	290	280	280	50°	NOT ALLOWED					50°	NOT ALLOWED				
	40°	850	850	850	850	40°	660	620	610	610	40°	440	410	410	410	40°	220	210	210	210	40°	NOT ALLOWED					40°	NOT ALLOWED				
	30°	850	840	840	840	30°	540	530	530	530	30°	340	330	330	330	30°	160	160	160	160	30°	NOT ALLOWED					30°	NOT ALLOWED				
	20°	810	790	790	790	20°	480	470	470	470	20°	270	270	270	270	20°	140	130	130	130	20°	NOT ALLOWED					20°	NOT ALLOWED				
	10°	760	760	760	760	10°	440	440	440	440	10°	240	240	240	240	10°	110	110	110	110	10°	NOT ALLOWED					10°	NOT ALLOWED				
	0°	760	760	760	760	0°	430	430	430	430	0°	220	220	220	220	0°	70	70	70	70	0°	NOT ALLOWED					0°	NOT ALLOWED				
	JIB 2.1 / STUB 2	80°	580	580	580	520	80°	580	580	580	520	80°	580	580	580	520	80°	580	580	580	520	80°	580	570	440	320	80°	520	270	190	160	
70°		580	580	580	500	70°	580	580	580	500	70°	580	580	580	500	70°	580	580	440	360	70°	290	230	190	170	70°	190	130	100	100		
60°		580	580	580	490	60°	580	580	580	490	60°	580	580	540	490	60°	430	370	340	330	60°	120	100	90	80	60°	NOT ALLOWED					
50°		580	580	570	490	50°	580	580	570	490	50°	500	440	420	420	50°	270	240	230	230	50°	NOT ALLOWED					50°	NOT ALLOWED				
40°		580	580	570	490	40°	540	500	490	490	40°	370	340	340	340	40°	190	170	170	170	40°	NOT ALLOWED					40°	NOT ALLOWED				
30°		580	570	570	490	30°	450	430	430	430	30°	290	270	270	270	30°	140	130	130	130	30°	NOT ALLOWED					30°	NOT ALLOWED				
20°		580	570	570	490	20°	390	380	380	380	20°	230	220	220	220	20°	110	110	110	110	20°	NOT ALLOWED					20°	NOT ALLOWED				
10°		570	570	570	490	10°	360	360	360	360	10°	200	200	200	200	10°	90	90	90	90	10°	NOT ALLOWED					10°	NOT ALLOWED				
0°		570	570	570	490	0°	350	350	350	350	0°	180	180	180	180	0°	50	50	50	50	0°	NOT ALLOWED					0°	NOT ALLOWED				
JIB 2.2 / JIB 3		80°	420	410	410	360	80°	420	410	410	360	80°	420	410	410	360	80°	420	410	410	360	80°	420	410	350	280	80°	420	200	130	110	
	70°	420	410	410	340	70°	420	410	410	340	70°	420	410	410	340	70°	420	410	410	340	70°	260	190	160	150	70°	130	70	50	50		
	60°	420	410	410	340	60°	420	410	410	340	60°	420	410	410	340	60°	390	320	290	280	60°	110	80	70	70	60°	NOT ALLOWED					
	50°	410	400	380	340	50°	410	400	380	340	50°	410	380	350	340	50°	240	210	200	200	50°	NOT ALLOWED					50°	NOT ALLOWED				
	40°	410	400	380	340	40°	410	400	380	340	40°	330	300	290	290	40°	170	150	150	150	40°	NOT ALLOWED					40°	NOT ALLOWED				
	30°	400	380	380	340	30°	390	360	360	340	30°	250	240	240	240	30°	120	110	110	110	30°	NOT ALLOWED					30°	NOT ALLOWED				
	20°	400	380	380	340	20°	340	330	330	330	20°	200	190	190	190	20°	100	100	90	90	20°	NOT ALLOWED					20°	NOT ALLOWED				
	10°	380	380	380	340	10°	310	310	310	310	10°	170	170	170	170	10°	70	70	70	70	10°	NOT ALLOWED					10°	NOT ALLOWED				
	0°	380	380	380	340	0°	300	300	300	300	0°	150	150	150	150	0°	40	40	40	40	0°	NOT ALLOWED					0°	NOT ALLOWED				

# URW-546-2 (4.0T X 2.5M)

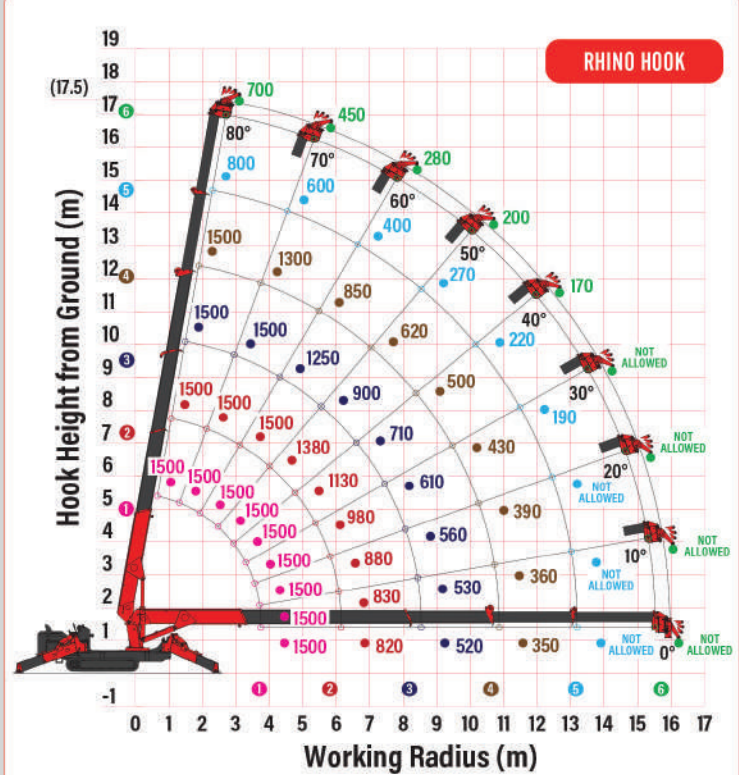
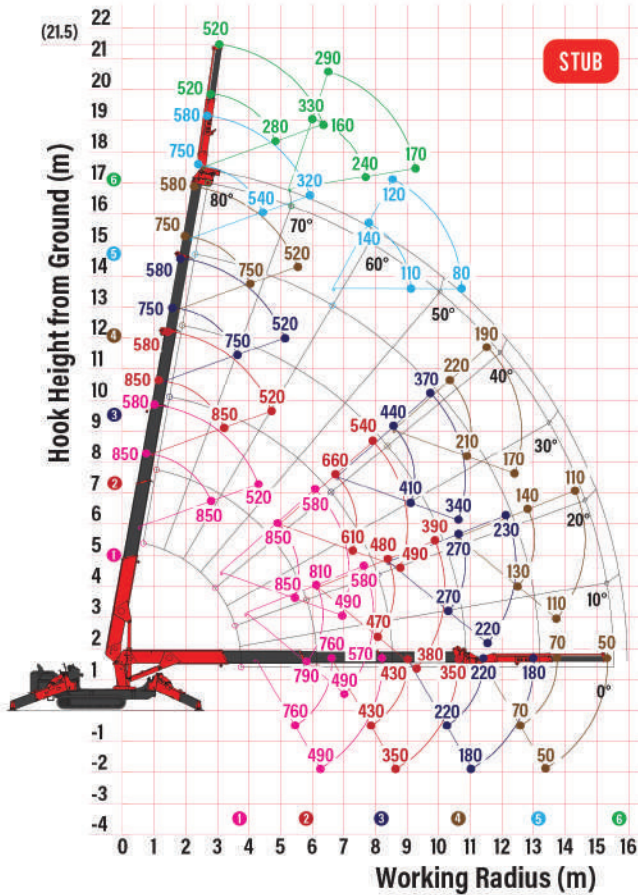

## OPTIONAL VARIABLE FOOTPRINT INCLUDING SLEW & HEIGHT LIMITATION

With the variable footprint option, the URW-546-2 is transformed and enables this mini crane to operate around fixed obstacles on site to suit the lifting requirements of each project.

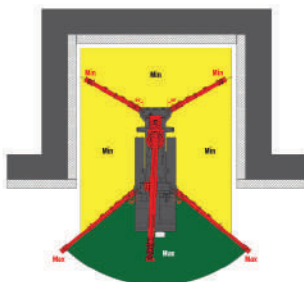

Height Limitation

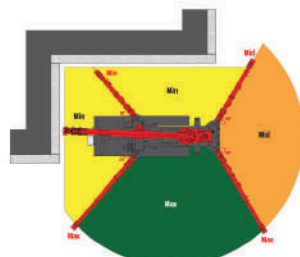

Variable Height Limitation



Slew Limitation

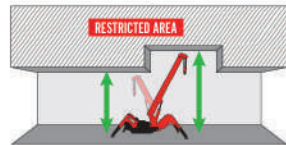

Variable Slew Limitation

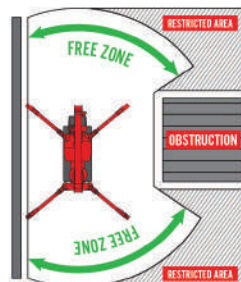

## RHINO HOOK NET RATED LOADS (kg) - OUTRIGGERS SET TO MAX, MID AND MIN

Max Outriggers	Boom Length					
	Boom 1	Boom 2	Boom 3	Boom 4	Boom 5	Boom 6
80°	1500	1500	1500	1500	800	700
70°	1500	1500	1500	1300	600	450
60°	1500	1500	1250	850	400	280
50°	1500	1380	900	620	270	200
40°	1500	1130	710	500	220	170
30°	1500	980	610	430	190	
20°	1500	880	560	390		
10°	1500	830	530	360		
0°	1500	820	520	350		

Mid Outriggers	Boom Length					
	Boom 1	Boom 2	Boom 3	Boom 4	Boom 5	Boom 6
78°	1500	1500	1500	1450	750	500
70°	1500	1500	1450	1100	550	240
60°	1500	1450	1100	780	380	130
50°	1500	1200	790	500	260	90
40°	1500	1020	600	310	200	60
30°	1430	870	470	250	160	
20°	1380	760	370	210		
10°	1360	730	330	190		
0°	1360	720	320	190		

Min Outriggers	Boom Length					
	Boom 1	Boom 2	Boom 3	Boom 4	Boom 5	Boom 6
78°	1500	1500	1500	1450	750	500
70°	1500	1500	1450	1000	530	240
60°	1500	1450	920	600	330	130
50°	1500	1200	610	360	170	80
40°	1500	970	430	210	100	50
30°	1430	770	330	150	70	
20°	1380	620	270	110		
10°	1360	550	230	100		
0°	1360	540	230	100		

Rhino Hook Tilt Angle (0-60° Same Performance)