

# URW-706

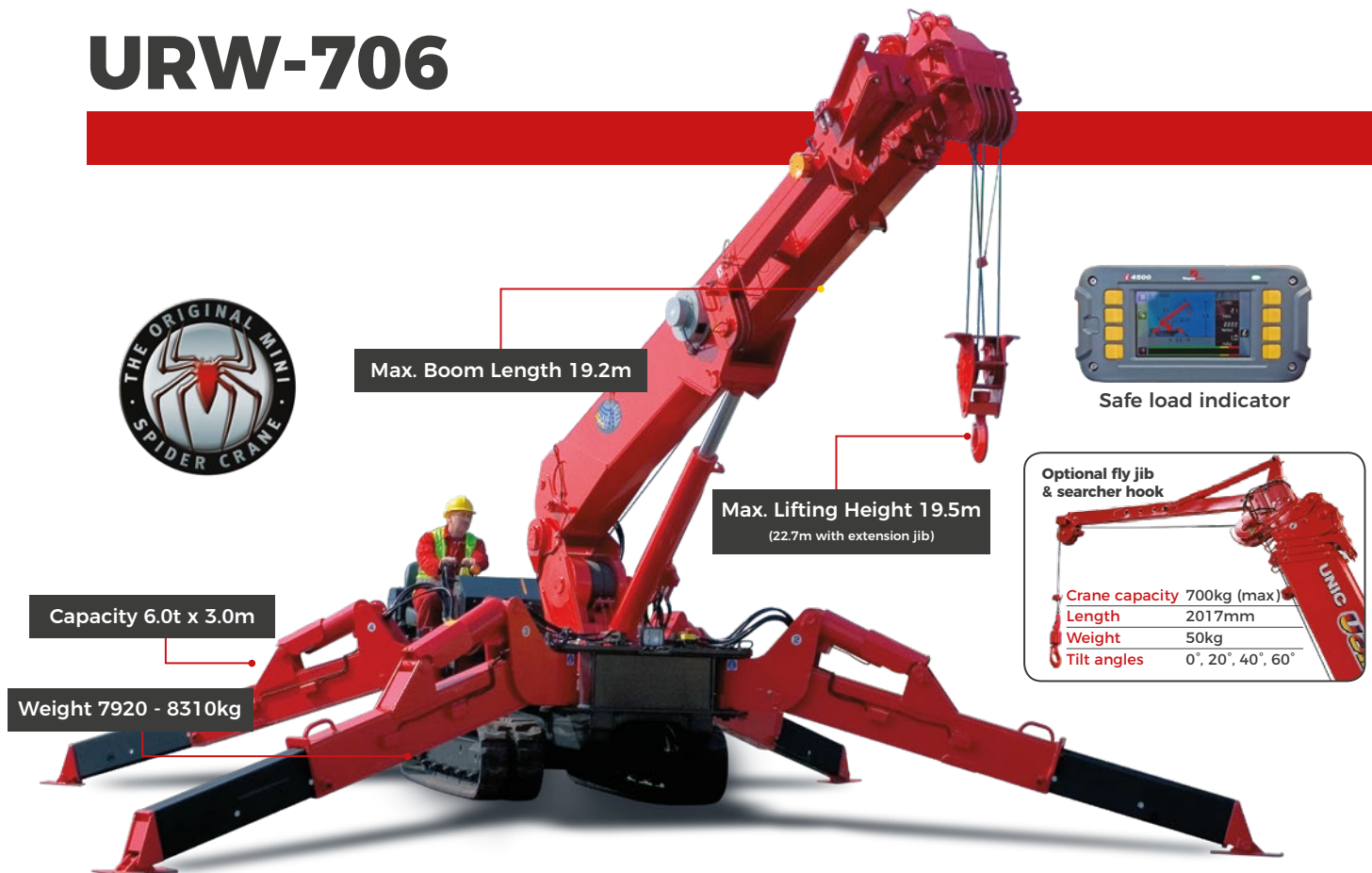

- Total width 1.67m
- Diesel powered and optional mains electric
- Zero length increase with electric option
- Radio remote control as standard
- Stowable fly (extension) jib (optional)
- Searcher hook (optional)
- Intelligent throttle activation for economy and ecology

**The URW-706 is a lifting heavyweight in the mini crane world.** With a 6 tonne capacity at 3.0m and a hook height of 19.5m it is one of the highest capacity UNIC cranes in the range, yet at 1670mm wide it is still narrow enough to gain access through a standard double doorway. For added lifting flexibility the URW-706 also features an optional searcher hook and a 3.1m long swing away fly jib, providing a maximum hook height of 22.7m. The new 706-2 hydraulic searcher hook provides a maximum hook height of 25.9m.

## Remotes



Standard radio remote control

## Crane Specifications

Crane capacity	capacity:	6.0t x 3.0m
Max working radius	max:	18.6m
Max lifting height	approx: URW-706-2:	19.5m (22.7m with second stage manual fly jib) 19.5m (25.2m with hydraulic fly jib, 25.9m with fixed hook)
Rope length	max:	23.75m (4 fall), 49.5m (2 fall), 101m (1 fall)
Dimensions	folded:	5610mm (l) x 1670mm (w) x 2185mm (h)
Weight	unladen:	7920kg + 160kg (8080kg with electric option) + 230kg (8310kg with searcher hook and fly jib attached)
Point loadings	Due to the many variables involved, point loadings are only available on request	
Hook speed	approx:	11m/min (with 5 layers and 4 falls)
Telescopic system	boom length: telescoping speed: boom type:	4.80 - 19.20m 14.4m/52 seconds 6 section hydraulically telescoping boom, hexagonal box construction
Derricking angle/speed	approx:	0 - 80°/16.0 seconds
Slewing angle/speed	approx:	360° (continuous) 2.5min rpm
Traction system	drive: travel speed: gradeability: track ground length: track ground pressure: track width:	hydrostatic 2-speed, stepless forward and reverse 0 - 2.9km/h ± 20° (vertical), 20° (traverse) 2240mm 43.6kPa (0.44 kg/cm <sup>2</sup> ) 400 mm
Engine	manufacturer: drive: maximum output: starting method: tank capacity:	Mitsubishi diesel (electric dual power option) 23.5kW (32.0PS) / 2500min rpm electric 74 litres
Electric motor	power: voltage:	7.5kW 400v AC 50/60Hz
Standard equipment	computer controlled moment limiter (safe load indicator), radio remote control, overwinding alarm, computer controlled intelligent voice warning system, multi-function operation by radio remote control, intelligent throttle activation, automatic hook stow, overload warning alarms, overload warning lamps, working area limitation	
Optional equipment	1 fall hook block, 2 fall hook block, mains electric dual power (400v), slew limitation, searcher hook 800kg, fly jib 800kg with single part line, 800kg capacity hydraulic fly jib (706-2)	

## 6.0t

Safe Working Load

### Rated Loads & Outrigger Positions

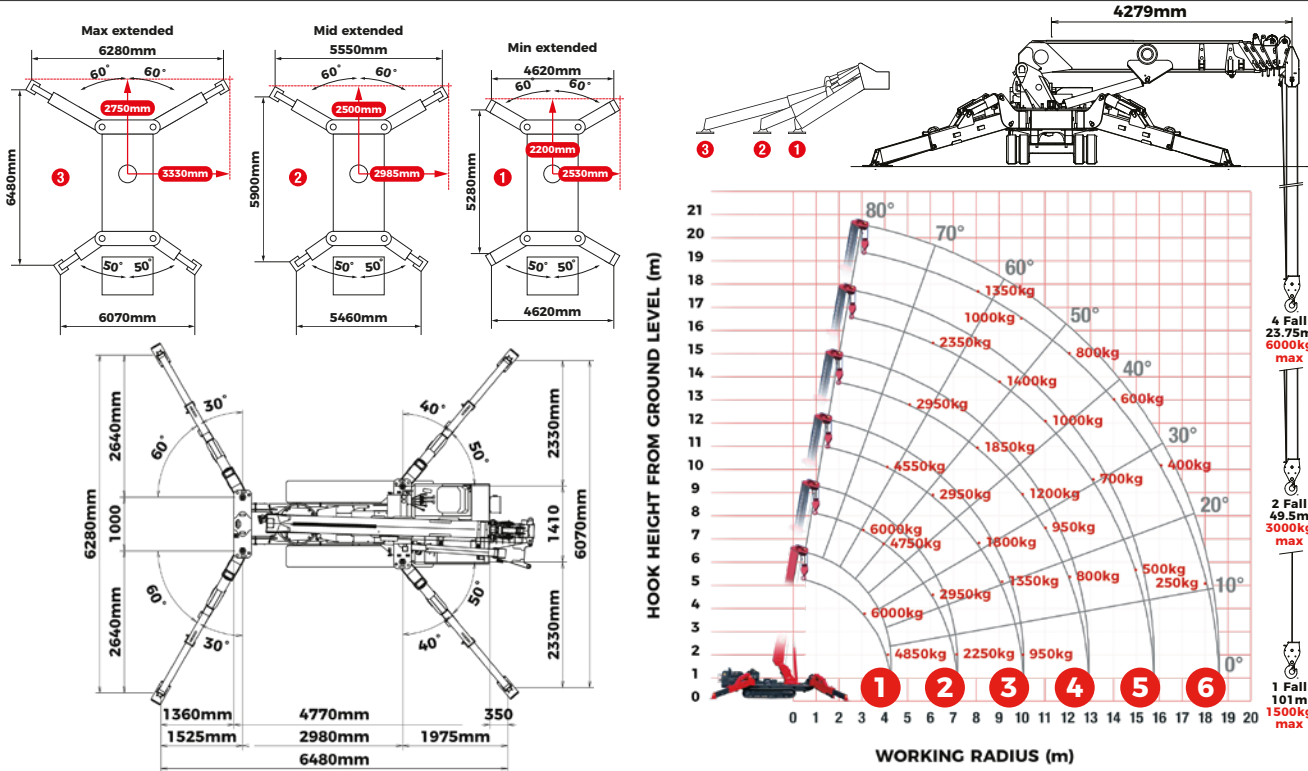

#### FIRST STAGE EXTENDED 4.8m BOOM LENGTH

Working radius	m	up to 2.7	3.0	3.5	4.0	4.3
Outrigger	Max-extended	kg 6000	6000	5450	4850	3950
	Mid-extended	kg 6000	6000	5450	4850	3950
	Min-extended	kg 6000	6000	5450	4550	3750

#### SECOND STAGE EXTENDED 4.8 - 7.7m BOOM LENGTH

Working radius	m	up to 2.0	3.0	3.5	4.0	5.0	6.0	7.0	7.2
Outrigger	Max-extended	kg 6000	6000	5350	4750	3750	2950	2250	2000
	Mid-extended	kg 6000	6000	5350	4750	3750	2450	1700	1550
	Min-extended	kg 6000	6000	5350	4650	2550	1650	1150	1050

#### THIRD STAGE EXTENDED 7.7 - 10.6m BOOM LENGTH

Working radius	m	up to 2.7	4.0	5.0	6.0	7.0	8.0	9.0	10.0	10.1
Outrigger	Max-extended	kg 4550	4550	3650	2950	2400	1800	1350	950	950
	Mid-extended	kg 4550	4550	3650	2550	1750	1300	950	700	700
	Min-extended	kg 4550	4550	2650	1700	1200	850	650	450	400

#### FOURTH STAGE EXTENDED 10.6 - 13.5m BOOM LENGTH

Working radius	m	up to 5.0	6.0	7.0	8.0	9.0	10.0	11.0	12.0	12.9
Outrigger	Max-extended	kg 2950	2550	2150	1850	1500	1200	950	800	450
	Mid-extended	kg 2950	2550	1850	1400	1100	850	650	550	400
	Min-extended	kg 2750	1850	1300	1000	750	550	430	330	240

#### FIFTH STAGE EXTENDED 13.5 - 16.3m BOOM LENGTH

Working radius	m	up to 6.0	8.0	9.0	10.0	11.0	12.0	13.0	14.0	15.0	15.8
Outrigger	Max-extended	kg 2350	1700	1400	1200	1000	850	700	600	500	400
	Mid-extended	kg 2350	1500	1150	950	750	600	500	400	300	250
	Min-extended	kg 1950	1050	800	650	500	400	300	230	170	130

#### SIXTH STAGE EXTENDED 16.3 - 19.2m BOOM LENGTH

Working radius	m	up to 8.0	10.0	12.0	14.0	16.0	18.0	18.6
Outrigger	Max-extended	kg 1350	1000	800	600	400	250	200
	Mid-extended	kg 1350	1000	650	450	300	200	150
	Min-extended	kg 1100	700	450	280	170	90	60



MINI CRANES

# URW-706 (Continued)

Shockless damping system for smooth stop when operated via remote control



The UNIC URW-706 features an optional 3.1m long swing away fly jib, together with an optional searcher hook, providing a maximum hook height of 22.7m.

The standard UNIC URW-706 provides a maximum hook height of 19.5m.



## Dimensions

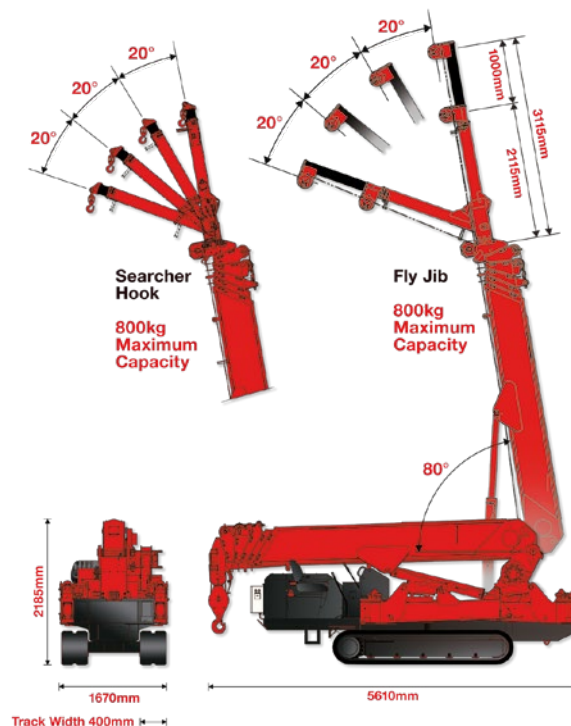

## Manual Fly Jib Working Range - 0° & 20°

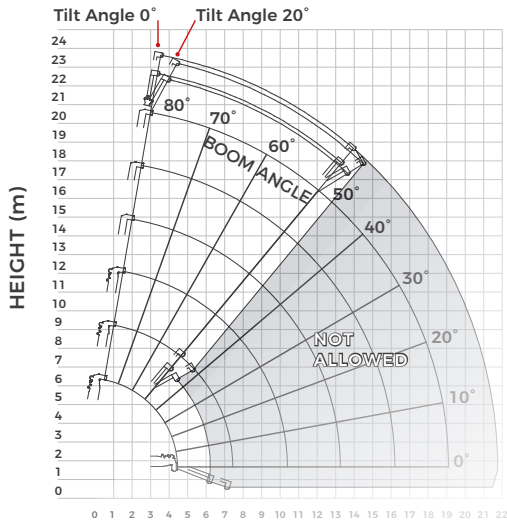

WORKING RADIUS (m) Tilt Angles 0° and 20°



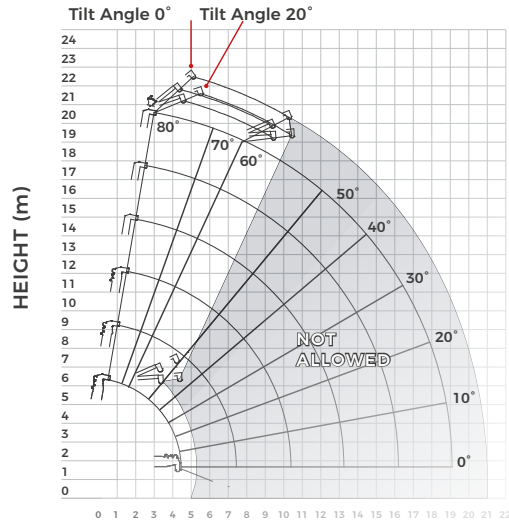

## Manual Fly Jib Working Range - 40° & 60°



WORKING RADIUS (m) Tilt Angles 40° and 60°

**Note:** The above figures are based on a no-load condition and do not include the deflection of the boom.

### Fly Jib - Angle Rated

ANGLE RATED	NET RATED LOADS (kg) AT EXTENSION JIB ANGLE			
				
BOOM ANGLE	0°	20°	40°	60°
80°	800	800	600	600
75°	800	800	600	600
70°	700	700	500	500
65°	600	600	400	400
60°	500	500	NOT ALLOWED	
55°	400	400		
50°	300	300		
<b>Lifting capacity</b>		800kg		
<b>Jib length</b>		retracted: 2.1m		
		extended: 3.1m		
<b>Weight</b>		205kg		
<b>Tilt angles</b>		0°, 20°, 40°, 60°		

### Searcher Hook - Radius Rated

RADIUS RATED	SEARCHER HOOK NET RATED LOADS (kg)		
			
WORKING RADIUS (m)	OUTRIGGERS MAX-EXTENDED	OUTRIGGERS MID-EXTENDED	OUTRIGGERS MIN-EXTENDED
7.0	800	800	800
8.0	800	800	610
9.0	800	700	420
10.0	800	550	250
10.5	800	490	200
11.0	650	430	160
11.5	550	370	120
12.0	470	310	100
13.0	330	230	NOT ALLOWED
14.0	260	150	
15.0	210	100	
<b>Lifting capacity</b>		800kg	
<b>Length</b>		2.21m	



Fly jib stowed position

